

**Flexy Compact**  
**Refrigerated stainless steel surface on**  
**cupboard (4GN) with wheels, overshelf**  
**with LED lights, H=750**

ITEM # \_\_\_\_\_

MODEL # \_\_\_\_\_

NAME # \_\_\_\_\_

SIS # \_\_\_\_\_

AIA # \_\_\_\_\_



**322068 (F14C4KW02S)**

Refrigerated stainless steel surface on cupboard (4 GN container capacity) with wheels, overshelf with LED lights and two stainless steel tray sliders, H=750mm (Nordic)

cooling efficiency. Pressed Stainless steel top 30mm deep with rounded edges and drain hole for easier cleaning. 750mm worktop height.

### Short Form Specification

**Item No.** \_\_\_\_\_

Compact design, ideal for space saving environments. AISI 304 Foldable tray sliders on long sides. Unit mounted on 125 mm wheels 2 swivel and 2 with brakes. Soft closing doors on operator side. Underneath ambient cupboard with doors. A type AISI 304 overshelf equipped with LED lights designed for extra increased visibility on the surface for charming food display. Sleek, minimalist glass structure, food and dust does not get trapped and easy to clean. Curved glass. Sturdy body construction with laminated panelings on 4 sides. Designed to serve the food on plates. Food introduced at the correct temperature maintains its core temperature according to Afnor Standards. Automatic defrosting guarantees evaporators clearance and efficient well cooling. Digital control with temperature display with precise adjustment (0,1°C). Fully compliant HACCP digital controls include visible alarms. The bottom is equipped with copper tubes to ensure proper cooling, with this system the air touches the cold surface and gets cooled. Equipped with a drain hole to easily discharge top condensation. Wells in 304 AISI stainless steel with rounded corners to facilitate cleaning operations. The well is also equipped with a drain hole. High-density expanded polyurethane foam with cyclopentane guarantees excellent well insulation to reduce energy dispersion. R290 refrigerant gas (GWP=3) to reduce environmental impact and increase

**APPROVAL:** \_\_\_\_\_

## Main Features

- Precise temperature control and setting at 0,1°C .
- As standard the product comes with digitally controlled thermostat which is in line of HACCP norms and provides visual alarm as a warning of the increasing or decreasing temperatures.
- Food introduced at the correct temperature maintains its core temperature according to Afnor Standards.
- Automatic defrosting guarantees evaporators clearance and efficient well cooling.
- Designed to serve the food on plates .
- When the temperature of the surface is cooled down to below 0 °C, the humidity in the air forms ice on the surface. If there is air circulation in the ambient, there is condensation on the surface instead of ice.
- Equipped with a drain hole to easily discharge top condensation.
- Surface mat is available as an accessory.
- Perfect compact design makes it ideal for space saving environments.
- CB and CE certified by a third party notified body.
- Soft closing doors on operator side.
- Underneath ambient cupboard with doors ideal for extra storage.
- Available options with online configurator: colors, tray sliders, overshelves, feet/wheels with desired diameter, height 750mm for kids.
- Glass insertions does not include any clamps and brackets making them very easy to clean.
- Overshelf equipped with LED lights.
- Optional plinth can be installed to cover the feet or the wheels.
- AISI 304 Tray slider in flush mounted stainless steel is installed on long sides and they can also be folded down to facilitate passage of the units through doorways.
- Ideal for servery lines without an operator.
- Unit mounted on 125 mm wheels 2 swivel and 2 with brakes.
- Stylish A type overshelf designed for extra increased visibility on the surface for charming food display.
- Curved glass.
- Available dimensions: 2, 3, 4 GN.
- Thanks to the sleek, minimalist glass structure, food and dust does not get trapped and the cleaning is made easier.

## Construction

- Electronic control with temperature display.
- Well bottom is inclined to facilitate water drainage.
- Well in 304 AISI stainless steel with rounded corners to facilitate cleaning operations. The well is also equipped with a drain hole.
- IPx2 water protection.
- The bottom is equipped with copper tubes to ensure proper cooling, with this system the air touches the cold surface and gets cooled.
- Pressed Stainless steel top 30mm deep with rounded edges and drain hole for easier cleaning.
- Overshelf in complete AISI 304.
- Top in AISI 304.
- Sturdy construction with laminated panelings on 4 sides.

## Sustainability



- Hydrocarbon refrigerant gas R290 for the lowest environmental impact (GWP=3) - CFC and HCFC free.
- High-density expanded polyurethane foam with cyclopentane guarantees excellent well insulation to reduce energy dispersion.

Front

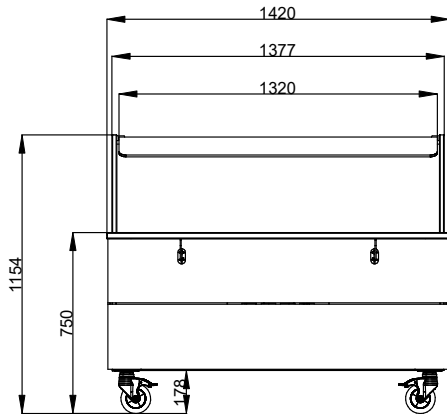

Side

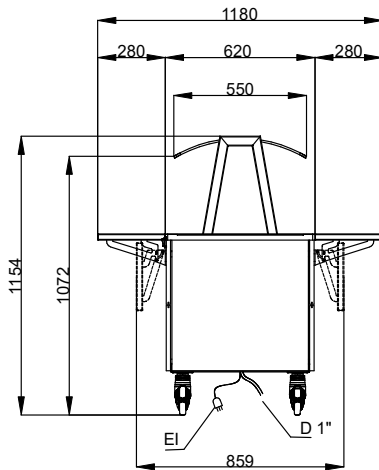

D = Drain  
 EI = Electrical inlet (power)

Top

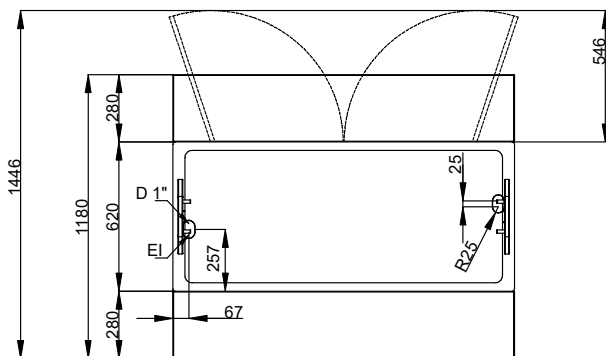

### Electric

Supply voltage:

322068 (F14C4KW02S) 220-240 V/1N ph/50 Hz

Electrical power max.:

0.62 kW

### Water:

Water drain outlet size:

3/4"

### Key Information:

N° of doors:	2
External dimensions, Width:	1420 mm
External dimensions, Depth:	1180 mm
External dimensions, Height:	1154 mm
Net weight:	145.5 kg
Shipping height:	1184 mm
Shipping width:	899 mm
Shipping depth:	1460 mm
Shipping volume:	1.55 m <sup>3</sup>
Set temperature:	-10 / 0 °C
Top temperature:	-10 / 0 °C

### Sustainability

Noise level: 59 dBA